



n55Plus

Slimline Vertical Louvre Blind By Louvolite / Solo Blinds

Detailed description

Louvolite Slimline® Vertical Blind System

- Unobtrusive, versatile, robust and reliable vertical blind system, designed to last many years
- Made using quality materials such as stainless steel and aluminium with corrosion resistant finishes
- British manufactured to the highest standards for over 25 years
- 10 year life cycle tested
- Tracks are supplied up to 5000mm wide (16'3") for wider window frames
- UV Stabilised prime plastics used to guard against ultra violet degradation.
- Direct drive tilt operation for positive control when opening and closing the blinds
- Self-aligning carrier trucks have limit stops allowing the louvre to rotate to 185°
- Spacing controlled by stainless steel spacer links for extra durability



Product guidance - As Standard

Operation:

Mono Wand Control as Standard
Cord / Chain Operation Option Available

Options

Variations:

- 89mm (3.5") or 127mm (5") Vane widths Available
- Plastic Chain
- Crank Operation
- 12v System
- Sewn In Weights
- Plastic Spacer Links

Blind size:

Maximum blind dimensions are based on fabric weight of 170 g/m².

- Minimum width: 127 mm.
- Maximum width: 5000 mm.
- Maximum drop: 8000 mm.
- Maximum area: 7.0 m².

Material:

Flame retardant fabric from standard range; consult manufacturer for details.

Product specification

Supplier Details:-

Solo Blinds
Unit 3 Trafalgar Court
South Nelson Ind. Est.
Cramlington
Northumberland
NE23 1WF
01670 733 788
www.soloblinds.co.uk
andy.ward@soloblinds.co.uk

Product reference	Slimline Vertical Louvre Blind
Material	Defiant FR Dart Blackout Fabric incorporating Biosafe Defiant FR Roe High Performance Screen Fabric Defiant FR Thames Dim-out Fabric Defiant FR Medway Fabric Louvolute Fabrics (various) Eclipse Fabrics (Various) Alutrade Fabrics (Various) Decora Fabrics (Various) Global Fabrics (Various)

Slimline® Vertical Blind System

Exploded diagram:



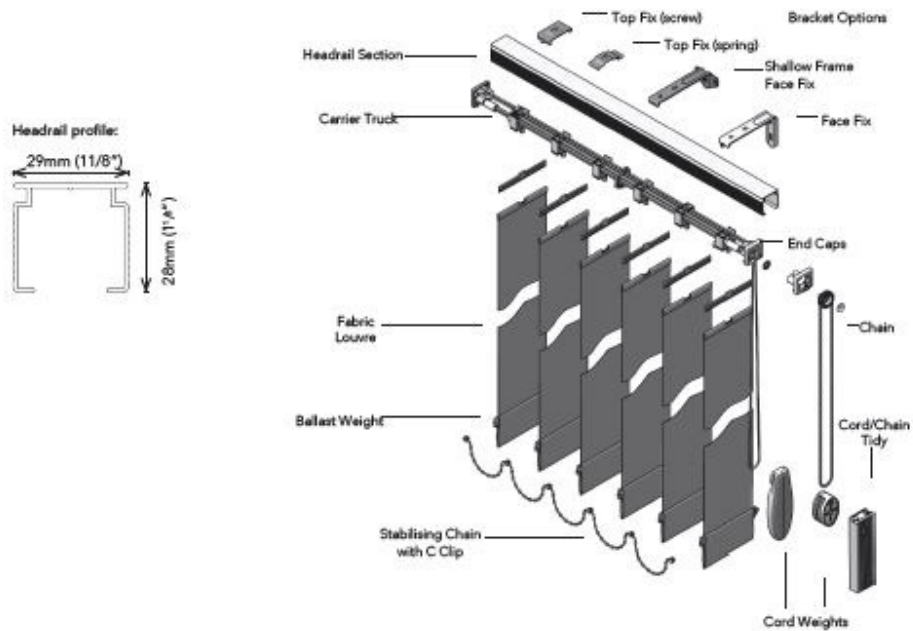



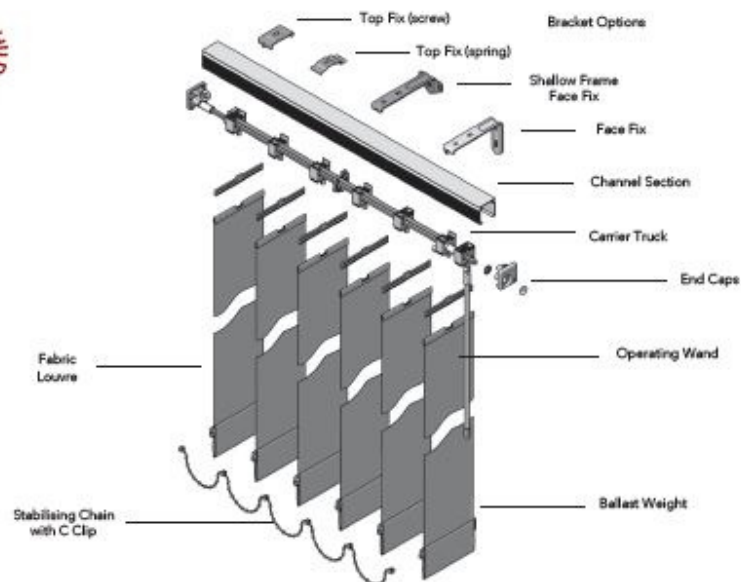

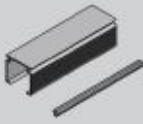
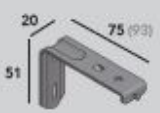

With Cord & Chain Operation

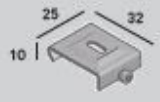
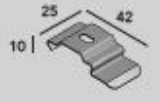

With Monocommand Wand Operation

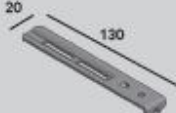
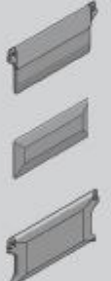

Slimline® Components

Headrail Section	Bracket Options
 <p>Slimline® Ribbed Headrail Product specification 100% aluminium Dimensions: 29mm (1 1/4") x 28mm (1 1/4") Length: 5m (5.5 yard) maximum Colour: white, brown or silver</p> <p>Tilt Rod Product specification Aluminium</p>	<p>2 Brackets required for blinds up to 1 metre width, 1 further bracket required for every additional metre.</p>  <p>Face fix brackets, 89mm or 127mm Product specification Mild steel, zinc plated and powder coated Colour: white, brown or silver</p> <p>Dimensions: 20mm (3/4") x 51mm (2") x 75mm (3") for 89mm (3 1/2") louvres 20mm (3/4") x 51mm (2") x 93mm (3 3/4") for 127mm (5") louvres</p>
<p>End Cap Sets</p>  <p>Slimline® End Caps Product specification Nylon Dimensions: 38.5mm (1 1/2") x 27.34mm (1 1/8") Colour: white, brown or grey</p>	 <p>Shallow frame face fix brackets, 89mm or 127mm Product specification Mild steel, zinc plated and powder coated Colour: white, brown or silver</p> <p>Dimensions: 45mm (1 3/4") x 32mm (1 1/4") x 75mm (3") for 89mm (3 1/2") louvres 45mm (1 3/4") x 32mm (1 1/4") x 93mm (3 3/4") for 127mm (5") louvres</p>
<p>Carrier Trucks</p>  <p>Spade Hook, self-aligning, 89mm or 127mm For use with stainless steel spacer links</p> <p>Spade Hook, fixed gear, 89mm or 127mm For use with stainless steel spacer links</p> <p>Product specification Truck body: nylon, link: stainless steel Dimensions: 24mm x 32mm x 12mm Colour: white, brown or grey</p>	 <p>Top fix brackets, screw Product specification Mild steel, zinc plated and powder coated Colour: white, brown or silver</p> <p>Dimensions: 25mm (1") x 10mm (3/8") x 32mm (1 1/4")</p>  <p>Top fix brackets, spring Product specification Mild steel, zinc plated and powder coated Colour: white, brown or silver</p> <p>Dimensions: 25mm (1") x 10mm (3/8") x 42mm (1 3/4")</p>
<p>Chain</p>  <p>Available in nickel plated brass, stainless steel or plastic. The pitch of the operating chain is designed to provide a smooth and silent operation. Available in a variety of colours, each chain system has a variety of connector units to allow for child safe operation where required.</p> <p>Product specification Acetal ball - colour: white or brown Zinc plated - colour: silver or gold Stainless steel Easy break chain connector for child safety</p>	 <p>Adjustable face fix brackets, 135mm - 185mm or 170mm - 225mm Product specification Mild steel, zinc plated and powder coated Colour: white, brown or silver</p> <p>Dimensions: short arm 20mm (3/4") x 51mm (2") x 135 - 185mm (5 1/4" x 7 1/4"), long arm 20mm (3/4") x 51mm (2") x 170 - 225mm (6 3/4" x 8 3/4")</p>
<p>Stabilising Chain with C Clip</p>  <p>Product specification Plastic Sizes: 89mm, 127mm and 50mm/63mm Colour: white, black or beige</p>	 <p>Extension Top fix brackets Product specification Mild steel, zinc plated and powder coated Colour: white, brown or silver</p> <p>Dimensions: short arm 20mm (3/4") x 130mm (5 1/4") long arm 20mm (3/4") x 165mm (6 1/2")</p>
<p>Louvre Ballast Weights</p>  <p>Ballast Weights, Moulded, Compact 89mm, 127mm Product specification Colour: white, beige or black</p> <p>Ballast Weights, Moulded, Plain 89mm, 127mm Product specification Colour: white</p> <p>Ballast Weights, Moulded, Standard 89mm, 127mm Product specification Colour: white or beige</p>	 <p>Side fix brackets, 89mm or 127mm Product specification Mild steel, zinc plated and powder coated Colour: white, brown or silver</p> <p>Dimensions: 20mm (3/4") x 51mm (2") x 75mm (3") for 89mm (3 1/2") louvres. 20mm (3/4") x 51mm (2") x 89mm (3 3/4") for 127mm (5") louvres</p>  <p>Pelmet brackets, 89mm or 127mm Product specification Colour: silver</p> <p>Dimensions: 55mm (2 1/8") x 20mm (3/4") x 90mm (3 1/2") for 89mm (3 1/2") louvres. 55mm (2 1/8") x 20mm (3/4") x 110mm (4 3/8") for 127mm (5") louvres</p>

Slimline® Bracket Dimensions

Key
89mm Louvre Dimensions
127mm Louvre Dimensions

● Face Fix Brackets

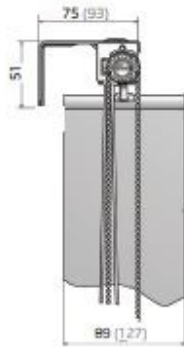

● Adjustable Face Fix Brackets

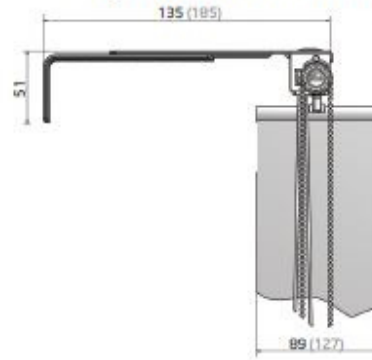

● Shallow Frame Face Fix Brackets



● Extension Top Fix Brackets



● Top Fix Brackets (screw)



● Side Fix Brackets

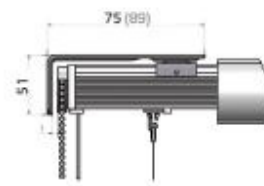

● Top Fix Brackets (spring)

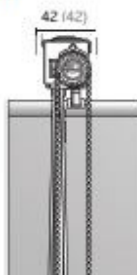

● Pelmet Brackets



Shaped Blind Options

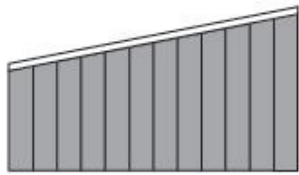

Angled Top

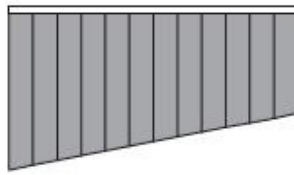

Angled Bottom

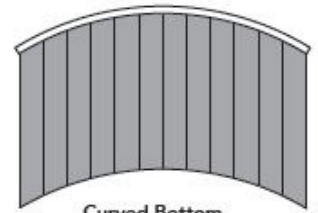

Curved Bottom

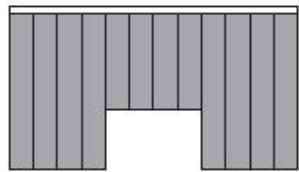

Shaped

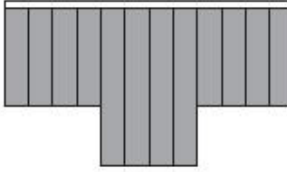

Stepped Bottom Edge

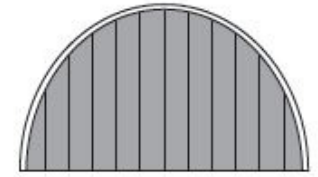

Arched Bottom

Bunching Options and Stacking Distances



One Way Bunch

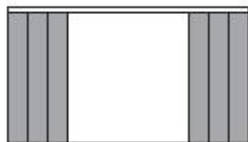

Split Bunch

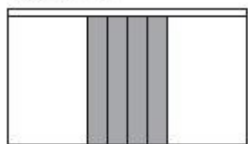

Centre Bunch

Bunching	89mm (3 1/2") Louvres	127mm (5") Louvres
One way	225mm (8 3/4") for 1st metre (3'3") width of blind	190mm (7 1/2") for 1st metre (3'3") width of blind. 115mm (4 1/2") for each additional metre
Split	225mm (8 3/4") for 1st metre (3'3") width of blind. 175mm (7") for each additional metre	135mm (5 1/2") for 1st metre (3'3") width of blind. 55mm (2 1/4") for each additional metre
Centre	165mm (6 1/2") for 1st metre (3'3") width of blind. 165mm (6 1/2") for each additional metre	115mm (4 1/2") for 1st metre (3'3") width of blind. 115mm (4 1/2") for each additional metre