

# Hand Operated Curtain Track Systems





## Hand Operated Curtain Track System

# Silent Gliss® 6290 Safety Track

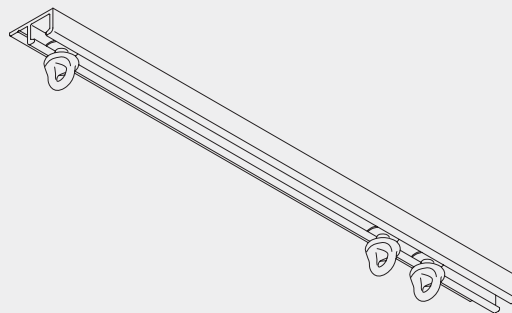

### Product Information

- Ceiling fix safety track - unique gliders designed to separate from profile when a specific weight is applied (4-6kg)
- Discreet hand drawn curtain track for contract applications - ideal for hospitals and schools
- Blue glider supplied for leading edge of curtain designed to separate at a higher weight (8-10kg) as more pressure is applied here when curtains are operated
- Profile is not pre-drilled in order to prevent impairing appearance from the room
- Profile fixed using self drilling screws. No gap between profile and ceiling
- For light to medium weight curtains
- White profile only
- Standard profile lengths available - 5m and 6m
- Unique blue and yellow safety gliders for easy identification



6290

## Profile, Bending and Specification Information

### 6290 Ceiling Fix

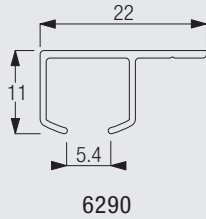

Specification Guide - download from [www.silentgliss.co.uk](http://www.silentgliss.co.uk) (password required)

Silent Gliss 6290 hand operated curtain track in white powder coated aluminium. Fix track to ceiling with self drilling wood screws. Special gliders to run in profile 6148 (10/m) and 6149 (2/length). Fix with secure endcovers 6122 at either end.

## Safety System Key Parts

### Safety Release Function

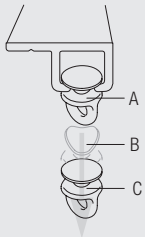

- A: Gliders can easily be clicked into profile
- B: Glider deforms under pressure
- C: Release under following pull weights: Glider 6148 (yellow for release between 4-6kg pull); Glider 6149 (blue for release between 8-10kg pull)

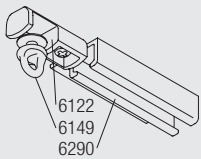

6122: Endstop (with end glider 6149 in place)

6290

6021/6290 system can assist in the prevention of self harm in hospitals, schools and psychiatric situations. Please see specific pull out weights on individual gliders. Please also note that the longer the individual track and the more gliders used, the cumulative total pull-out weight when in a stacked position will increase and therefore support more weight.

A risk assessment of the area should always be carried out.

## Fitting Information

### Maximum recommended fixing points

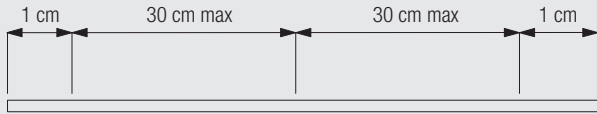

**Important:** when installing system 6290 with the intention of reducing the opportunity of self harm, Silent Gliss recommend the following:

- The first and final fixings must be no more than 1cm from either end of the track.
- If fixing to a baton, ensure the profile does not project past the edge of the baton.
- If fixing to uneven wall surfaces (with or without batons), use a sealant or similar compound around the baton/track to ensure no gaps remain.

## Fitting Options

### Ceiling fix with 6290 with single profile

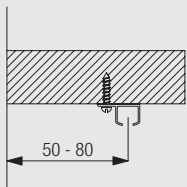

The final distance may be outside of the recommendations above depending on curtain heading, make-up and any obstructions.

### Ceiling fix with two or multiple profiles

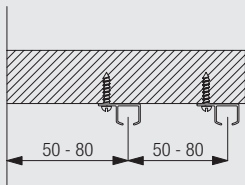

The final distance may be outside of the recommendations above depending on curtain heading, make-up and any obstructions.



6290

## Standard Accessories

6122 Endstop

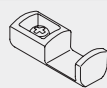

6148 Safety glider (yellow)



6149 Safety glider (blue)



6290 Profile



## Optional Accessories

0688 Wood screw (self drilling)

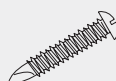

10430 Draw rod with hook, 50cm

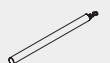

10431 Draw rod with hook, 75cm



10432 Draw rod with hook, 100cm



10433 Draw rod with hook, 125cm



10434 Draw rod with hook, 150cm



## Useful Information and Sewing Accessories

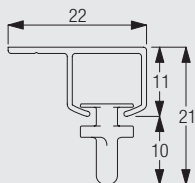

Diagram uses safety glider measured to the inside of the glider eye.

3562 Standard tape



3582 Hook



3599 Hook



6290



6290

[www.silentgliss.co.uk](http://www.silentgliss.co.uk)

Silent Gliss Ltd  
Pyramid Business Park  
Poorhole Lane  
Broadstairs  
Kent  
CT10 2PT  
Great Britain

Tel: 0044 (0) 1843 863571  
Fax: 0044 (0) 1843 864503  
[sales@silentgliss.co.uk](mailto:sales@silentgliss.co.uk)